

Modular Blocks Size 10 (CETOP 05) with Built-in Valves

Vertically integrated valves according to diagram

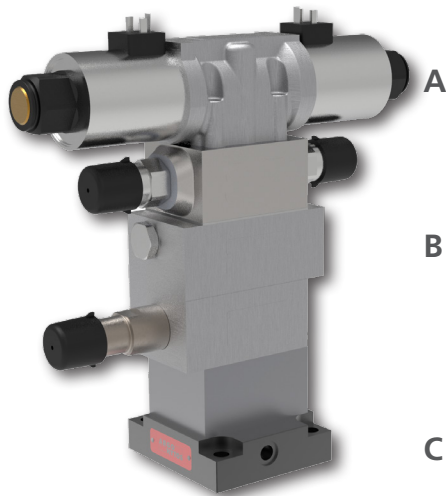

Technical Features

- › Simple creation of complicated hydraulic circuits
- › Flexible connection solution
- › Wide range of valves available
- › Circuit creation without the use of pipes and hoses
- › Saves build-in space

Functional Description

Vertically integrated modular blocks with built-in valves are assembled into a single unit using four M6 or 1/4-20 UNC threaded bolts and mounted to a base, e.g. to a subplate, a parallel circuit manifold with side ports or another block. The connection plate diagram conforms with ISO 4401. The surface of upper block is usually closed with connected directional control valve with body or with a blanking plate.

Connection diagram size 10 according to ISO 4401

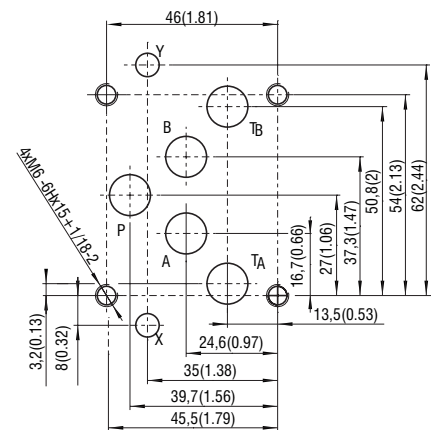

Example of a vertically integrated valves size 10

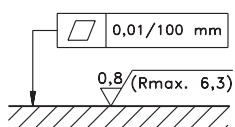
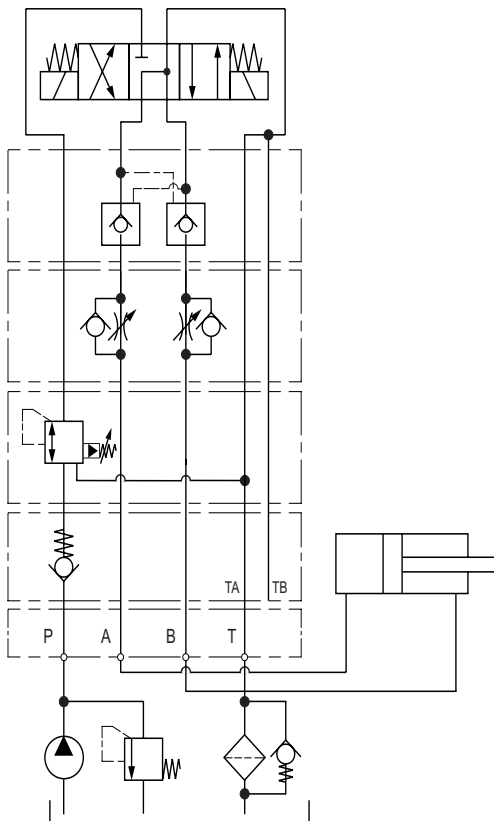

Required surface quality of the counterpart

Content

	page
A. Valves with body on the upper surface (CETOP valves)	2
Directional control valves with body	2
Proportional directional control valves with body	2
Blanking plates	2
B. Valves built-in modular blocks	3
Directional control valves, spool type	3
Poppet valves, pilot operated	4
Check valves	5
Check valves, pilot to open	6
Pressure relief valves, direct acting	6
Pressure relief valves, pilot operated	7
Pressure relief valves operated by solenoid	8
Proportional pressure relief valves	8
Pressure reducing – relieving valves, direct acting	9
Pressure reducing – relieving valves, pilot operated	9
Proportional pressure reducing – relieving valves	10
Overcenter valves	11
Throttle valves with bypass check valve and throttle valves	12
Flow control valves with 2-way pressure compensator	13
Pressure compensators	14
C. Subplates and manifolds	15
Subplates DP	15
Adaptor plates DA-10/06	15
Base manifolds	15
Base manifolds with a connected parallel circuit manifolds	16
D. Fastening material - studs and nuts	17
Metric threads	17

A. Valves with Body on the Upper Surface (CETOP Valves)

Directional Control Valves with Body

The valves control the movement direction of the actuator and usually close the upper surface of vertically integrated modular valves. The most commonly used are solenoid operated with one solenoid (4/2) or two solenoids (4/3, 4/2 with detent assembly of spool). However, they can also be operated manually, hydraulically or pneumatically.

Product name	Datasheet no.	Max. pressure [bar (PSI)] P,A,B / T	Max. flow [l/min (GPM)]	Description
RPE4-10	HA 4039	350 / 210 (5080 / 3050)	140 (37)	Solenoid operated directional control valve
RPEW4-10	HA 4046	350 / 210 (5080 / 3050)	140 (37)	Solenoid operated directional control valve with wire box
RPEL1-10	HA 4084	250 / 210 (3630 / 3050)	100 (26.4)	Solenoid operated directional control valve, lightline
RPR1-10	HA 4044	350 / 210 (5080 / 3050)	140 (37)	Manually operated directional control valve (with locked spool position or proportional control)

RPE4-10

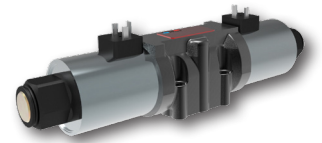

RPEW4-10

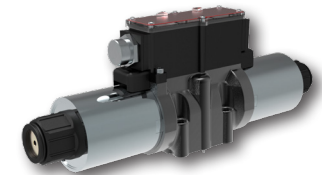

Proportional Directional Control Valves with Body

The valves can be used instead of standard valves. In addition to controlling the fluid flow direction, they enable smooth control of volumetric flow, and thus the moving speed of piston rod or hydraulic motor. To ensure the repeatability of regulation, it is necessary to stabilize the pressure drop on the control edges of spool using a two-way or a three-way pressure compensator. An electronic control unit is necessary for the valve control. It can be integrated on the top surface of the valve (on-board ECU) or located on an external standardised plate. Proportional valves allow comfortable, continuous remote control via electric command signal. The built-in spool position sensor as a feedback reduces the valve hysteresis to 0.5 %.

Product name	Datasheet no.	Max. pressure [bar (PSI)] P,A,B / T	Max. flow [l/min (GPM)]	Description
PRM6-10	HA 5115	350 / 210 (5080 / 3050)	80 (21.1)	Proportional directional control valve without feedback
PRM7-10	HA 5116	350 / 210 (5080 / 3050)	80 (21.1)	Proportional directional control valve with spool position & system feedback
PRM9-10	HA 5130	350 / 210 (5080 / 3050)	60 (15.9)	Proportional directional control valve with spool position & system feedback and possible connection to CAN-bus line

PRM9-10

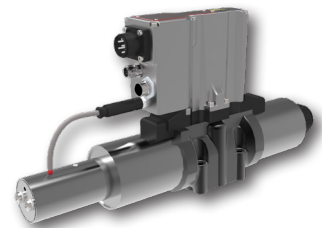

Blanking Plates

They can be used for closing the channels on the top surface of vertical integrated modular valves instead of a top valve with body. The plates enable various channels connection.

Product name	Datasheet no.	Material / max. pressure [bar (PSI)]	Description
DK1-10	HA 0003	Grey cast Iron / 320 (4640)	Blanking plate

DK1-10



Caution:

Modular blocks made of gray cast iron may be used up to pressure of 350 bar (5080 PSI). For higher system pressure up to 420 bar (6090 PSI), it is necessary to use modular blocks made of steel.



Caution:

The valve pressure drop (Δp_v), given for specific flow volume in the valve datasheet, is increased by the pressure loss of the modular block (Δp_b) after assembly. The amount depends of the way of internal connection.

$$\Delta p = \Delta p_v + \Delta p_b$$

B. Valves Built-in Modular Blocks

Directional Control Valves, Spool Type

2/2 directional control valves, built in modular block, are often used as stop valves, connecting or unloading valves.

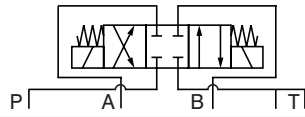

Functional description	Functional symbol	Valve	Max. flow [l/min (GPM)]	Modular blocks	Ordering no. * Block height mm(in)
Stop valve in A channel		SD2E-B2/H2I11 HA 4060	60 (15.9)	SB-10B2-1A1-GV-B HA 0028	34249300 50 (1.97)
Stop valve in A and B channels		SD2E-B2/H2I11 HA 4060	60 (15.9)	SB-10B2-2C1-GV-B HA 0028	34528800 50 (1.97)
Stop valve in T channel		SD2E-B2/H2I11 HA 4060	60 (15.9)	SB-10B2-1T1-GV-B HA 0028	32504500 50 (1.97)
Unloading valve P → T		SD2E-B2/H2I12 HA 4060	60 (15.9)	SB-10B2-1PT1-GV-B HA 0028	30568300 50 (1.97)

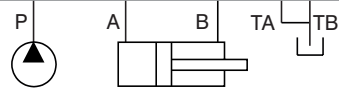

* block only

Valves:

Product name	Datasheet no.	Max. pressure [bar (PSI)]	Max. flow [l/min (GPM)]	Description
SD2E-B2/H	HA 4060	350 (5080)	60 (15.9)	Screw-in cartridge 2/2 directional control valve, spool type (C-10-2)

SD2E-B2/H



Poppet Valves, Pilot Operated

Pilot operated poppet valves close leak free only in one direction, according to the valve symbol. In the opposite direction the valve is open.

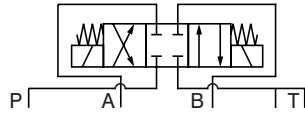

Functional description	Functional symbol	Valve	Max. flow [l/min (GPM)]	Modular blocks	Ordering no.* Block height mm(in)
Stop valve in A channel, flow direction from the actuator		SD3E-B2/H2O2 HA 4063	75 (19.8)	SB-10B2-1A1-GV-B HA 0028	34249300 50 (1.97)
Stop valves in A and B channels, flow direction from the actuator		SD3E-B2/H2O2 HA 4063	75 (19.8)	SB-10B2-1C1-GV-B HA 0028	34528800 50 (1.97)
Safety (stop) valve in A channel, flow direction from the actuator		SD3E-B2/H2L2 HA 4063	75 (19.8)	SB-10B2-1A1-GV-B HA 0028	34249300 50 (1.97)
Safety (stop) valves in A and B channels, flow direction from the actuator		SD3E-B2/H2L2 HA 4063	75 (19.8)	SB-10B2-1C1-GV-B HA 0028	34528800 50 (1.97)



* block only

Valves:

Product name	Datasheet no.	Max. pressure [bar (PSI)]	Max. flow [l/min (GPM)]	Description
SD3E-B2/H	HA 4063	420 (6090)	75 (19.8)	Screw-in cartridge 2/2 poppet valve, pilot operated (C-10-2)

SD3E-B2

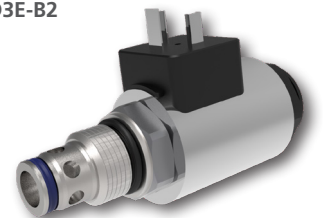

Check Valves

Check valves enable the fluid flow only in one direction. They are often connected to the pump pressure pipeline to prevent a backflow caused by excessive load on the actuator. The modular block can be provided with one or two built-in check valves. The free flow direction can be chosen.

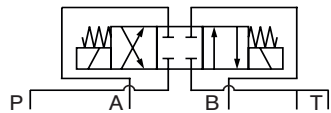

Functional description	Functional symbol	Valve	Max. flow [l/min (GPM)]	Modular blocks	Ordering no.* Block height mm(in)
Check valve in P channel, flow direction to the actuator		MVJ3-10P HA 5020	100 (26.4)		50 (1.97)
Check valve in A channel, flow direction from the actuator		MVJ3-10A HA 5020	100 (26.4)		50 (1.97)
Check valve in B channel, flow direction from the actuator		MVJ3-10B HA 5020	100 (26.4)		50 (1.97)
Check valve in T channel, flow direction from the actuator		MVJ3-10T HA 5020 SC1F-B2 HA 5017	100 (26.4) 120 (31.7)	SB-10B2-1T1-GV-B HA 0028	50 (1.97) 32504500 50 (1.97)
Check valve in A channel, flow direction to the actuator		MVJ3-10C HA 5020 SC1F-B2 HA 5017	100 (26.4) 120 (31.7)	SB-10B2-1A1-GV-B HA 0028	50 (1.97) 34249300 50 (1.97)
Check valve in B channel, flow direction to the actuator		MVJ3-10D HA 5020	100 (26.4)		50 (1.97)
Check valves in A and B channels, flow direction to the actuator		MVJ3-10AB HA 5020	100 (26.4)		50 (1.97)
Check valves in P and T channels, flow direction P to the actuator and T from the actuator		MVJ3-10PT HA 5020	100 (26.4)		50 (1.97)



* block only

Valves:

Product name	Datasheet no.	Max. pressure [bar (PSI)]	Max. flow [l/min (GPM)]	Description
MVJ3-10	HA 5020	350 (5080)	100 (26.4)	Check valve built-into modular block
SC1F-B2	HA 5017	420 (6090)	120 (31.7)	Screw-in cartridge check valve (C-10-2)

MVJ3-10

SC1F-B2

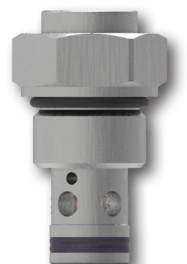

Check Valves, Pilot to Open

Pilot operated check valves are used for load holding when the pump is switched off. The valve can be built in A, B or both channels of modular block according to acting direction of the load.

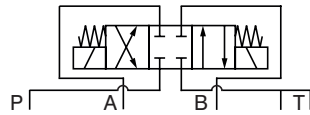

Functional description	Functional symbol	Valve	Max. flow [l/min (GPM)]	Modular blocks	Ordering no.* Block height mm(in)
Pilot operated valve in A channel, control pressure from B		VJR3-10/MA HA 5035	140 (37)		50 (1.97)
Pilot operated valve in B channel, control pressure from A		VJR3-10/MB HA 5035	140 (37)		50 (1.97)
Pilot operated valves in A and B channels		VJR3-10/MC HA 5035	140 (37)		50 (1.97)



* block only

Valves:

Product name	Datasheet no.	Max. pressure [bar (PSI)]	Max. flow [l/min (GPM)]	Description
VJR3-10/M	HA 5035	350 (5080)	140 (37)	Pilot operated check valve built into modular block

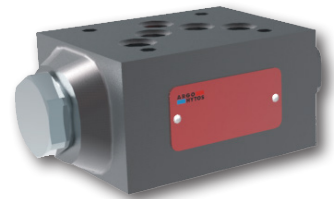

Pressure Relief Valves, Direct Acting

Pressure relief valves limit the maximum system pressure and protect the system against overloading. They are connected parallel to the pump or actuator.

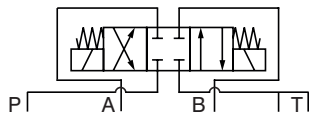

Functional description	Functional symbol	Valve	Max. flow [l/min (GPM)]	Modular blocks	Ordering no.* Block height mm(in)
Pressure relief valve in P channel (P → T)		SR1A-B2 HA 5064	60 (15.9)	SB-10B2-1PT1-GV-B HA 0028	30568300 50 (1.97)
Two independent pressure relief valves (A → T and B → T)		SR1A-B2 HA 5064	60 (15.9)	SB-10B2-2D1-GV-B HA 0028	34568000 50 (1.97)



* block only

Valves:

Product name	Datasheet no.	Max. pressure [bar (PSI)]	Max. flow [l/min (GPM)]	Description
SR1A-B2	HA 5064	420 / 250 (6090 / 3630)	60 (15.9)	Screw-in cartridge pressure relief valve, direct acting (C-10-2)



Pressure Relief Valves, Pilot Operated

Pressure relief valves limit the maximum system pressure and protect the system against overloading. They are connected parallel to the pump or actuator.

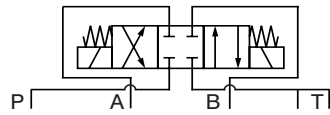

Functional description	Functional symbol	Valve	Max. flow [l/min (GPM)]	Modular blocks	Ordering no.* Block height mm(in)
Pressure relief valve in P channel (P → T)		VPN2-10/MP HA 5164 SR4A-B2 HA 5065	150 (39.6) 100 (26.4)	SB-10B2-1PT1-GV-B HA 0028	50 (1.97) 30568300 50 (1.97)
Pressure relief valve in A channel (A → T)		VPN2-10/MA HA 5164	150 (39.6)		50 (1.97)
Pressure relief valve in B channel (B → T)		VPN2-10/MB HA 5164	150 (39.6)		50 (1.97)
Crossport pressure relief valves (A ↔ B)		VPN2-10/MC HA 5164	150 (39.6)		50 (1.97)
Two independent pressure relief valves (A → T and B → T)		VPN2-10/MD HA 5164 SR4A-B2 HA 5065	150 (39.6) 100 (26.4)	SB-10B2-2D1-GV-B HA 0028	50 (1.97) 34568000 50 (1.97)

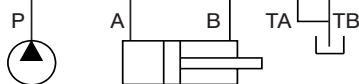

* block only

Valves:

Product name	Datasheet no.	Max. pressure [bar (PSI)]	Max. flow [l/min (GPM)]	Description
VPN2-10/M	HA 5164	350 (5080)	150 (39.6)	Pressure relief valve, pilot operated, built into modular block
SR4A-B2	HA 5065	350 / 100 (5080 / 1450)	100 (26.4)	Screw-in cartridge pressure relief valve, pilot operated (C-10-2)

VPN2-10/M

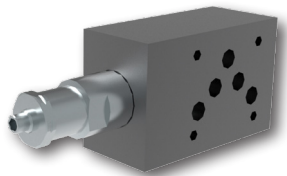

SR4A-B2



Pressure Relief Valves Operated by Solenoid

The solenoid operated relief valves switch between two adjusted pressure values or adjusted maximum and minimum system pressure (combined relief and unloading function). The pressure values are adjusted mechanically with the help of two adjusting screws.

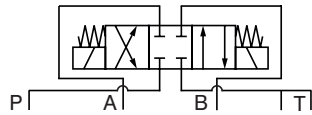

Functional description	Functional symbol	Valve	Max. flow [l/min (GPM)]	Modular blocks	Ordering no.* Block height mm(in)
Pressure relief / unloading valve in P channel (P → T), switching between adjusted p_1 and p_2		SR4E-B2 HA 5068	60 (15.9)	SB-10B2-1PT1-GV-B HA 0028	30568300 50 (1.97)

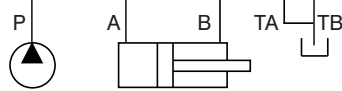

* block only

Valves:

Product name	Datasheet no.	Max. pressure [bar (PSI)]	Max. flow [l/min (GPM)]	Description
SR4E-B2	HA 5068	350 / 100 (5080 / 1450)	60 (15.9)	Screw-in cartridge pressure relief valve operated by solenoid (C-10-2)

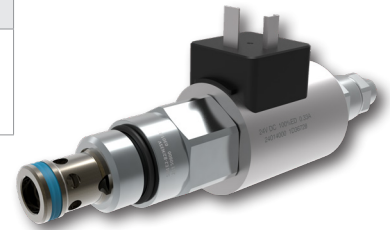

Proportional Pressure Relief Valves

The valves enable continuous adjustment of the maximum system pressure depending on the command control signal. The valves with a negative characteristic create the maximum pressure at zero control signal (opposite function)

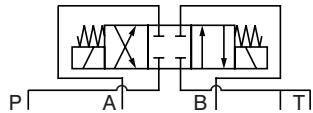

Functional description	Functional symbol	Valve	Max. flow [l/min (GPM)]	Modular blocks	Ordering no.* Block height mm(in)
Continuous adjustment of maximum pressure in P channel (P → T)		SR4P2-B2 HA 5117	80 (21.1)	SB-10B2-1PT1-GV-B HA 0028	30568300 50 (1.97)
		SRN4P1-B2 HA 5138	80 (21.1)	SB-10B2-1PT1-GV-B HA 0028	30568300 50 (1.97)

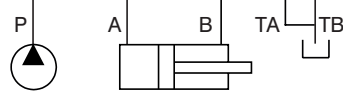

* block only

Valves:

Product name	Datasheet no.	Max. pressure [bar (PSI)]	Max. flow [l/min (GPM)]	Description
SR4P2-B2	HA 5117	350 / 100 (5080 / 1450)	80 (21.1)	Screw-in cartridge proportional pressure relief valve, pilot operated (C-10-2)
SRN4P1-B2	HA 5138	350 / 100 (5080 / 1450)	80 (21.1)	Screw-in cartridge proportional pressure relief valve with negative characteristic, pilot operated (C-10-2)

SR4P2-B2

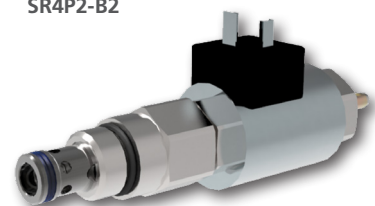

Pressure Reducing Valves, Direct Acting

Reducing valves maintain a constant set pressure. They are often used for adjusting the pressure on an actuator, it means the force acting on the piston rod or the torque on the shaft of hydraulic motor. Three-way valves protect the pipeline leading to the actuator against pressure overloading as a relief valves and allow the back flow from the actuator to the tank.

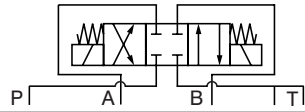

Functional description	Functional symbol	Valve	Max. flow [l/min (GPM)]	Modular blocks	Ordering no.* Block height mm(in)
Reduced pressure setting in P channel, additionally gauge port M		SP2A-B3 HA 5146	60 (15.9)	SB-10B3-1P2-GV-B HA 0028	30533700 50 (1.97)

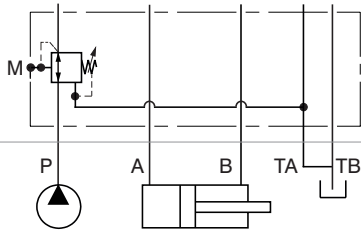

* block only

Valves:

Product name	Datasheet no.	Max. pressure [bar (PSI)] P / T	Max. flow [l/min (GPM)]	Description
SP2A-B3	HA 5146	420 / 200 (6090 / 2900)	60 (15.9)	Screw-in cartridge reducing-relieving valve, direct acting (C-10-3)



Pressure Reducing Valves, Pilot Operated

Reducing valves maintain a constant set pressure. They are often used for adjusting the pressure on an actuator, it means the force acting on the piston rod or the torque on the shaft of hydraulic motor. Three-way valves protect the pipeline leading to the actuator against pressure overloading as a relief valves and allow the back flow from the actuator to the tank. Pilot operated valves need permanent small flow through the pilot stage to assure the continuous constant pressure regulation.

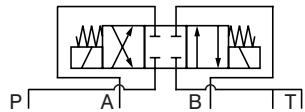

Functional description	Functional symbol	Valve	Max. flow [l/min (GPM)]	Modular blocks	Ordering no.* Block height mm(in)
Reduced pressure setting in P channel, additionally gauge port M		VRN2-10/MP HA 5156	150 (39.6)	SB-10B3-1P2-GV-B HA 0028	50 (1.97)
Reduced pressure setting in A channel, bypass check valve for back flow, additionally gauge port M		SP4A-B3 HA 5144	60 (15.9)		30533700 50 (1.97)
Reduced pressure setting in B channel, bypass check valve for back flow, additionally gauge port M		VRN2-10/MA HA 5156	150 (39.6)		50 (1.97)
		VRN2-10/MB HA 5156	150 (39.6)		50 (1.97)

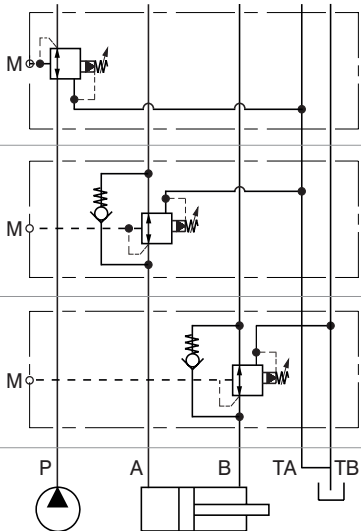

* block only

Valves:

Product name	Datasheet no.	Max. pressure [bar (PSI)] P / T	Max. flow [l/min (GPM)]	Description
VRN2-10/M	HA 5156	320 / 160 (4640 / 2320)	150 (39.6)	Pressure reducing-relieving valve, pilot operated, built into modular block
SP4A-B3	HA 5144	350 / 100 (5080 / 1450)	60 (15.9)	Screw-in cartridge reducing-relieving valve, pilot operated (C-10-3)

VRN2-10/M

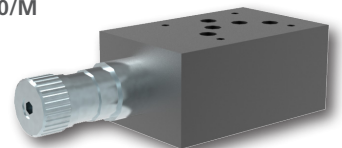

SP4A-B3



Proportional Pressure Reducing Valves

Proportional reducing valves are used for remote continuous adjusting of the pressure on an actuator, it means the force acting on the piston rod or the torque on the shaft of hydraulic motor. Three-way valves protect the pipeline leading to the actuator against pressure overloading as a relief valves and allow the back flow from the actuator to the tank. The valves with a negative characteristic create the maximum pressure at zero control signal (opposite function).

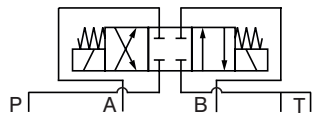

Functional description	Functional symbol	Valve	Max. flow [l/min (GPM)]	Modular blocks	Ordering no.* Block height mm(in)
Reduced pressure setting in P channel, additionally gauge port M		SP4P2-B3 HA 5123	60 (15.9)	SB-10B3-1P2-GV-B HA 0028	30533700 50 (1.97)
		SRN4P1-B2 HA 5139	60 (15.9)	SB-10B3-1P2-GV-B HA 0028	30533700 50 (1.97)

* block only

Valves:

Product name	Datasheet no.	Max. pressure [bar (PSI)] P / T	Max. flow [l/min (GPM)]	Description
SP4P2-B3	HA 5123	350 / 100 (5080 / 1450)	60 (15.9)	Screw-in cartridge proportional pressure reducing valve, pilot operated (C-10-3)
SPN4P1-B3	HA 5139	350 / 100 (5080 / 1450)	60 (15.9)	Screw-in cartridge proportional pressure reducing valve with negative characteristic, pilot operated (C-10-3)

SP4P2-B3

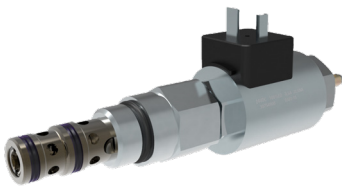

Overcenter Valves

Overcenter valves ensure the load position when the pump is off and enable continuous, safe movement control of the load acting in the movement (negative) direction of the actuator, which is accelerated by load. Non-balanced and fully balanced valves with ventilation of spring space are available.

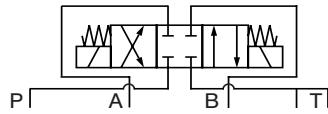

Functional description	Functional symbol	Valve	Max. flow [l/min (GPM)]	Modular blocks	Ordering no.* Block height mm(in)
Non-balanced overcenter valve in A channel, controlled by pressure from B channel		SO5A-CP3/H HA 5194	80 (21.1)	SB-10CP3-1A1-GV-B HA 0028	41722200 70 (2.76)
Non-balanced overcenter valve in B channel, controlled by pressure from A channel		SO5A-CP3/H HA 5194	80 (21.1)	SB-10CP3-1B1-GV-B HA 0028	41723000 70 (2.76)
Non-balanced overcenter valves in A and B channels, crossport controlled		SO5A-CP3/H HA 5194	80 (21.1)	SB-10CP3-2C2-GV-B HA 0028	41721800 70 (2.76)
Fully balanced overcenter valve in A channel, controlled by pressure from B channel		SOB5A-CP3/H HA 5195	80 (21.1)	SB-10CP3-1A1-GV-B HA 0028	41722200 70 (2.76)
Fully balanced overcenter valve in B channel, controlled by pressure from A channel		SOB5A-CP3/H HA 5195	80 (21.1)	SB-10CP3-1B1-GV-B HA 0028	41723000 70 (2.76)
Fully balanced overcenter valves in A and B channels, crossport controlled		SOB5A-CP3/H HA 5195	80 (21.1)	SB-10CP3-2C2-GV-B HA 0028	41721800 70 (2.76)



* block only

Valves:

Product name	Datasheet no.	Max. pressure [bar (PSI)]	Max. flow [l/min (GPM)]	Description
SO5A-CP3/H	HA 5194	350 / 280 (5080 / 4060)	80 (21.1)	Screw-in cartridge overcenter valve, non-balanced
SOB5A-CP3/H	HA 5195	350 / 280 (5080 / 4060)	80 (21.1)	Screw-in cartridge overcenter valve, fully balanced with atmospheric ventilation

SO5A-CP3/H

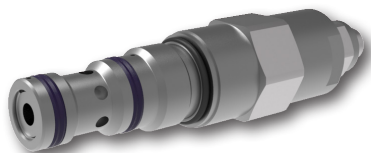

SOB5A-CP3/H



Throttle Valves with Bypass Check Valves and Throttle Valves

Throttle valves are used as flow restrictors for flow regulation and thus velocity regulation of actuator. The flow can be regulated upstream or downstream the actuator depending on bypass check valve orientation which can be changed thanks to additional plate with sealing rings.

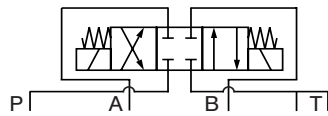

Functional description	Functional symbol	Valve	Max. flow [l/min (GPM)]	Modular blocks	Ordering no.* Block height mm(in)
Throttle valve in A channel, flow regulation upstream the actuator		VSO3-10/MA HA 5076	160 (42.3)		50 (1.96) (block + plate)
Throttle valve in B channel, flow regulation upstream the actuator		VSO3-10/MB HA 5076	160 (42.3)		50 (1.96) (block + plate)
Throttle valve in A and B channels, flow regulation upstream the actuator		VSO3-10/MC HA 5076	160 (42.3)		50 (1.96) (block + plate)
Throttle valve in A channel, flow regulation downstream the actuator		VSO3-10/MA HA 5076	160 (42.3)		50 (1.96) (block + plate)
Throttle valve in B channel, flow regulation downstream the actuator		VSO3-10/MB HA 5076	160 (42.3)		50 (1.96) (block + plate)
Throttle valve in A and B channels, flow regulation downstream the actuator		VSO3-10/MC HA 5076	160 (42.3)		50 (1.96) (block + plate)
Throttle valves in A and B channels		ST21A-B2 HA 5134	140 (37)	SB-10B2-2C1-GV-B HA 0028	34528800 50 (1.97)

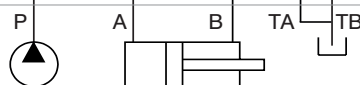

* block only

Valves:

Product name	Datasheet no.	Max. pressure [bar (PSI)]	Max. flow [l/min (GPM)]	Description
VSO3-10/M	HA 5076	350 (5080)	160 (42.3)	Double throttle valve with bypass check valves in the form of modular block
ST21A-B2	HA 5134	350 (5080)	140 (37)	Screw-in cartridge throttle valve (C-10-2)

The separate o-ring plate allows to turn modular block. The meter-out throttling can be changed to the meter-in throttling by simple rotating the block only at MC type. At the types MA and MB, the valve position in channels A and B is changed due to the one axis symmetry of the mounting interface of modular block. This can be solved by ordering the opposite type (see table below) or by additional changing the valve and end plug positions each other.

Recommended types depending on valve position and throttling mode:

Type / valve in channel	Meter-out throttling	Meter-in throttling
MA / A	VSO3-10/MA	VSO3-10/MB, turn the block
MB / B	VSO3-10/MB	VSO3-10/MA, turn the block
MC / A, B	VSO3-10/MC	VSO3-10/MC, turn the block

ST21A-B2

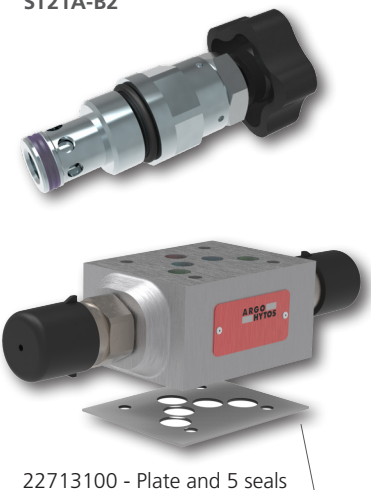

22713100 - Plate and 5 seals

Flow Control Valves with Two-way Pressure Compensator

Flow control valves with two-way pressure compensator maintain a set flow rate independent of the pressure induced by load and supply pressure fluctuation. Constant pressure drop on the valve and thus the constant flow rate is maintained by throttling.

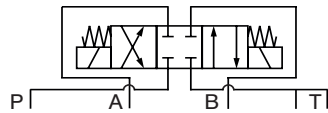

Functional description	Functional symbol	Valve	Max. flow [l/min (GPM)]	Modular blocks	Ordering no.* Block height mm(in)
Flow control valve with 2-way pressure compensator in A channel, flow regulation upstream the actuator		SF22A-B2 HA 5067	40 (11)	SB-10B2-1A1-GV-B HA 0028	34249300 50 (1.97)
Flow control valves with 2-way pressure compensator in A and B channels, flow regulation upstream the actuator		SF22A-B2 HA 5067	40 (11)	SB-10B2-2C1-GV-B HA 0028	34528800 50 (1.97)



* block only

Valves:

Product name	Datasheet no.	Max. pressure [bar (PSI)]	Max. flow [l/min (GPM)]	Description
SF22A-B2	HA 5067	350 (5080)	40 (11)	Screw-in cartridge flow control valve with 2-way pressure compensator (C-10-2)

SF22A-B2



Pressure Compensators

Pressure compensators are used for stabilisation of pressure drop on valves. When used with proportional directional control valves they assure repeatability of flow regulation at the load or supply fluctuation. Two-way pressure compensator regulates the pressure drop by throttling of the flow, three-way pressure compensator by flow dividing. The two-way pressure compensator has two possible connections. Meter-in connection is used for positively acting load, meter-out connection is used for negatively acting load (in the moving direction of actuator).

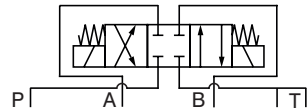

Functional description	Functional symbol	Valve	Max. flow [l/min (GPM)]	Modular blocks	Ordering no.* Block height mm(in)
Two-way pressure compensator in P channel, meter-in connection, controlled by pressure from A channel, additionally port for LS regulation		TV2-102/MA HA 5169	80 (21.1)		70 (2.76)
Two-way pressure compensator in P channel, meter-in connection, controlled by pressure from B channel, additionally port for LS regulation		TV2-102/MB HA 5169	80 (21.1)		70 (2.76)
Two-way pressure compensator in P channel, meter-in connection, controlled by pressure from A or B channel via load shuttle valve, additionally port for LS regulation		TV2-102/MC HA 5169	80 (21.1)		70 (2.76)
Two-way pressure compensator with bypass check valve in A and B channels, meter-out connection additionally port for LS regulation		TV2-102/MD HA 5169	80 (21.1)		100 (3.94)
Two-way pressure compensator with bypass check valve in A channel, meter-out connection additionally port for LS regulation		TV2-102/ME HA 5169	80 (21.1)		70 (2.76)
Two-way pressure compensator with bypass check valve in B channel, meter-out connection additionally port for LS regulation		TV2-102/MF HA 5169	80 (21.1)		70 (2.76)
Three-way pressure compensator controlled by pressure from A channel additionally port for LS regulation		TV2-103/MA HA 5170	80 (21.1)		70 (2.76)
Three-way pressure compensator controlled by pressure from B channel additionally port for LS regulation		TV2-103/MB HA 5170	80 (21.1)		70 (2.76)
Three-way pressure compensator controlled by pressure from A and B channels via load shuttle valve additionally port for LS regulation		TV2-103/MC HA 5170	80 (21.1)		70 (2.76)

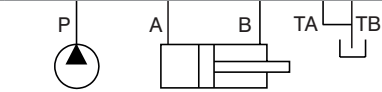

* block only

Valves:

Product name	Datasheet no.	Max. pressure [bar (PSI)]	Max. flow [l/min (GPM)]	Description
TV2-102/M	HA 5169	350 (5080)	80 (21.1)	Two-way pressure compensator built into modular block
TV2-103/M	HA 5170	350 (5080)	80 (21.1)	Three-way pressure compensator built into modular block

TV2-102/M



TV2-103/M



C. Subplates and Manifolds

Integrated modular blocks create a flexible control assembly, which is connected to the hydraulic circuit with the help of subplate or base block provided threaded side ports.

Subplates DP

Subplates DP-10 are used for connection of one (CETOP) valve with body or integrated modular assembly. The under side is provided with threaded ports for fittings and pipeline connection.

Product name	Datasheet no.	Material / Max. pressure [bar (PSI)]	Description
DP-10	HA 0002	Gray cast iron / 350 (5080)	Subplate

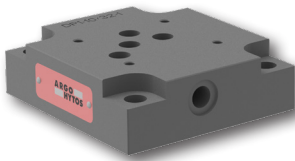

Adaptor Plates DA-10/06

Adaptor plates DA-10/06 allow a conversion from connection diagram size 10 acc. to ISO 4401 to size 06.

Product name	Datasheet no.	Material / Max. pressure [bar (PSI)]	Description
DA-10/06	HA 0027	Steel / 350 (5080)	Adaptor plate for conversion from connection diagram size 10 to size 06

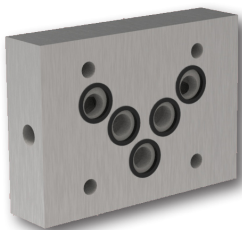

Base Manifold

Base manifold DP6 with built-in pressure relief valve is designed for assembly of one (CETOP) valve with body or integrated modular assembly. It has been designed for hydraulic powerpacks but can be used separately.

Product name	Datasheet no.	Material / Max. pressure [bar (PSI)]	Max. flow [l/min (GPM)]	Description
DP6-10	HA 0012	Steel / 350 (5080)	120 (31.7)	Base manifold with built-in pressure relief valve

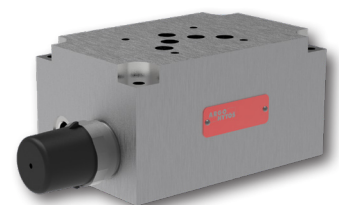

Base Manifolds with a Connected Parallel Circuit Manifolds

The base manifold is a multifunctional part for connection of parallel circuit manifold with groups of integrated valves, creating the control circuit. The base manifold enables connection to the pump and back pipeline in the building the complete hydraulic drives. The upper surface is designed for connection of PD10 parallel circuit manifold with vertically integrated modular valves. Side connecting pattern size 10 is designed for (CETOP) valve with body, which is used for drive control.

Product name	Datasheet no.	Material / Max. pressure [bar (PSI)]	Description
ZB10	HA 0021	Aluminium alloy / 250 (3630) Steel / 320 (4640)	Base manifold for power packs
PD10	HA 0008	Aluminium alloy / 250 (3630)	Parallel circuit manifold with common P and T channels designed for assembly to the base manifold ZB06

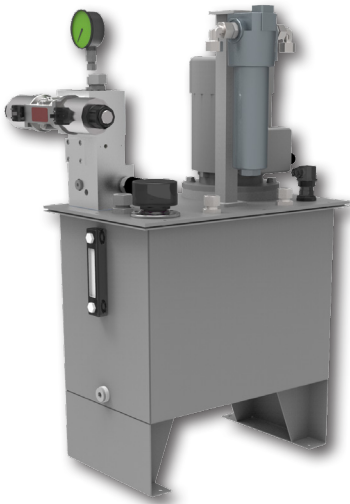

Example of using the basic manifold ZB10 with connected parallel circuit manifold PD10 on the SA power pack.

PD10

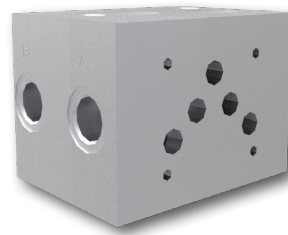

ZB10

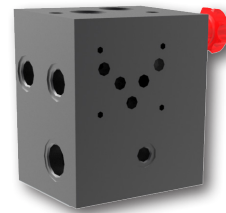

D. Fastening Material

Fastening material for vertical integration of modular valves and the calculation of the length of studs and screws can be found in Datasheet no. HA 0020.

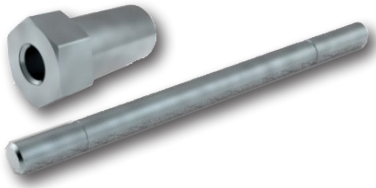

Metric Threads dimensions in millimeters (in)

Studrod M6xL (length L see the table)
Strength class - GR.8 ISO 10.9

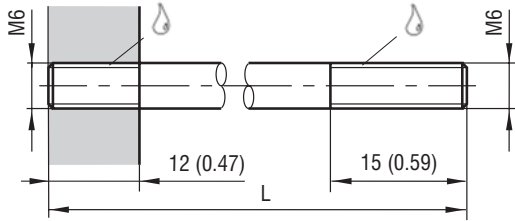

Studnut M6

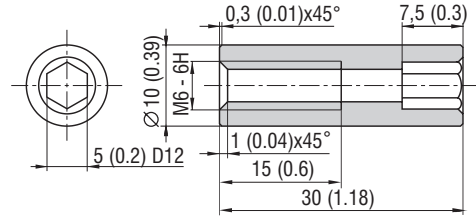

Calculating of Stud Length

Calculation formula: $L = LP + \sum HM + LB + LN$

- L - total length of the studrod
- LP -thread length projection into subplate / block = 12 mm (0.47 in)
- $\sum HM$ - SUM of all heights of all installed sandwich valves
- LB - length of directional valve projection = 30 mm (1.18 in)
- LN - length of thread in the nut ($LN_{min} - LN_{max}$) = 8 mm (0.31 in) - 14 mm (0.55 in)

Studrods - order numbers of separate elements or kits

M6		Torque to 14 Nm (10.3 lbf.ft)			
Item	Length L	Weight	Item number		Max. pressure
	[mm]	kg / 100 pcs	1pc	Kit*	[bar]
Studrod	92	1.9	20200200	16106800	350
Studrod	100	2.0	15610000	33881400	350
Studrod	103	2.1	20200400	16106700	350
Studrod	109	2.2	20200500	33881500	350
Studrod	115	2.4	20200600	33881600	350
Studrod	125	2.6	20200700	27483500	350
Studrod	128	2.7	20200900	33881800	350
Studrod	133	2.8	20201000	33881900	350
Studrod	136	2.8	20201100	16107900	350
Studrod	139	2.9	20201200	33882000	350
Studrod	143	3.0	15609900	16106900	350
Studrod	147	3.1	20201400	16108000	350
Studrod	152	3.2	20201500	16107000	320
Studrod	157	3.3	20201600	33882100	320
Studrod	163	3.5	20201800	33882200	320
Studrod	167	3.6	28802300	33882300	320
Studrod	172	3.7	28802500	33882400	320
Studrod	179	3.8	20201900	33882500	320
Studrod	183	3.9	20202000	33882600	320
Studrod	187	4.0	20202100	16107100	320
Studrod	194	4.1	20202300	16107200	320
Studrod	199	4.2	20202400	16108100	320
Studrod	203	4.3	20202500	16107300	250
Studrod	209	4.5	20202600	33882700	250
Studrod	219	4.7	20202700	33882800	250

M6		Torque to 14 Nm (10.3 lbf.ft)			
Item	Length L	Weight	Item number		Max. pressure
	[mm]	kg / 100 pcs	1pc	Kit*	[bar]
Studrod	224	4.8	20202900	27484200	250
Studrod	236	5.0	20203100	16107400	250
Studrod	245	5.2	20203200	16107500	250
Studrod	253	5.4	20203300	16107800	210
Studrod	256	5.5	20203400	33883000	210
Studrod	259	5.6	20203500	33883200	210
Studrod	265	5.7	28802600	33883300	210
Studrod	273	5.9	28802700	33883500	210
Studrod	279	6.0	20203600	33883600	210
Studrod	287	6.1	20203700	16107600	210
Studrod	295	6.4	20203800	16107700	210
Studrod	300	6.5	28802800	33883700	180
Studrod	309	6.7	24233700	33883800	180
Studrod	314	6.9	28802900	33883900	180
Studrod	320	7.2	28803000	33884000	180
Studrod	328	7.5	28803200	33884100	180
Studrod	367	7.8	31044000	33884200	180
Nut	M6	1.3	16115200		

Caution!
*Kits include 4 studrods + 4 nuts

Remarks:

This document is intended to aid circuit creation by means of vertical integration and identification of modular blocks in relation to their individual valves. If the required modular valve was not found in the above selection, we recommend you the following procedure:

- › Select the required valve from the constantly updated product catalogue at www.argo-hytos.com
- › Available blocks for specific valve are listed in the table "Technical Data" of datasheet.
- › Select the appropriate modular block for screw-in cartridge valves according to type and function of the valve in datasheet no. HA 0028.
- › In the same way, you can choose in-line body for screw-in cartridge valves from datasheet SB 0018.
- › If you need to make the cavity for screw-in cartridge valve in your own block, cavity drawings and the associated tools are found in datasheet SMT 0029.
- › It is possible to realize different hydraulic function using the unified type of block. E.g. the same block type 1PT1 can be used for pressure relief valve and appropriate type of unloading valve.
- › Generally, there is a recommendation to not connect pressure line (P) to the electric operated valves in such way that the solenoid core tube is loaded by undesired pressure peaks. These valves should be connected to the pump in radial direction.
- › Connection symbols of pilot operated poppet valves (one-way valves) and pressure valves show their connection which is necessary for their proper function. For better understanding see data sheets of the valves.
- › If the required modular blocks is not listed, please contact our sales department.