

A110T60

printed on: 04-09-2024



TECHNICAL INFO

Media type	WIRE MESH
Efficiency	60 µm
Max working pressure	12 bar
Seals	NBR
Temperature range	-30°C +100°C

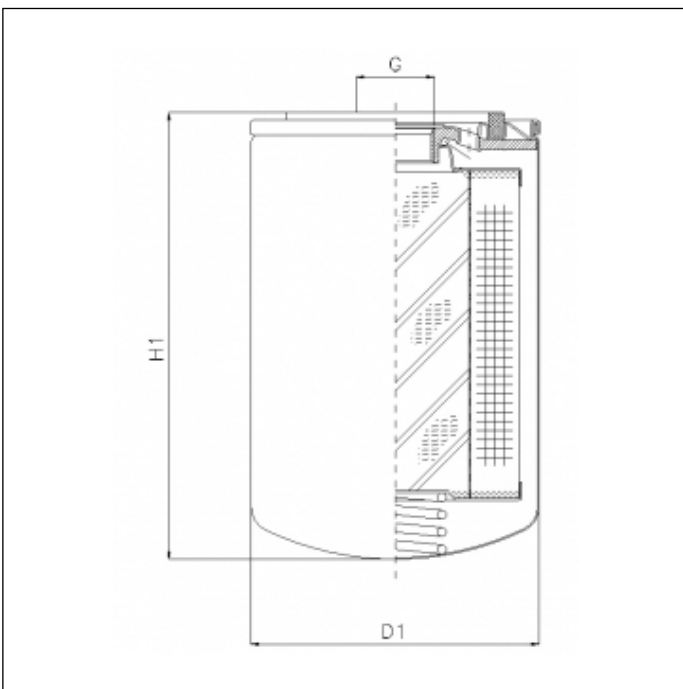

OVERALL DIMENSIONS

D1	96,0 mm
H1	147,0 mm
G	G 3/4

Technical information may change without notice. Image and drawing are representative only